

# SG SLIDING GATE BOPLAN SAFETY GATES SPECIFICATION SHEET

Revision: 13 December 2018 5:06 PM

Boplan reference:  
SG02.. HP plus sliding gates  
SG03.. TB plus sliding gates



## PRODUCT SPECIFICATIONS

APPLICATION		
Environment	Gate in between pedestrian zone and high traffic zone. Indoor use only -10°C up to + 40°C	
Features	Range of standards lengths available. Can be used in combination with different FLEX IMPACT® systems. UV resistant. Impervious to most chemical products**	
Advisory speed	Not intended for vehicle impact.	
MATERIAL		
Gate rails	Polyolefin - UV resistant - Fire class HB* - Non conductive - Impervious to most chemical products**	
Fixations	ZC / SS	
Wheel support / U profile	Lacquered steel	
STANDARD COLORS		
Rails (sliding part)	Black / yellow	
Rails (fixed part)	Yellow	
Posts	Black	
Wheel support / U profile	Black	
FIXATIONS (included)		
	ZINC COATED	INOX
EXPANSION ANCHOR 	Length = 120 mm Size = M12 Drill hole diameter = 12 mm Max load (pull out) = 7.9 kN	Length = 120 mm Size = M12 Drill hole diameter = 12 mm Max load (pull out) = 7.9 kN
THREADED ROD (WITH CHEMICAL ANCHOR) 	Length = 120 mm Size = M12 Drill hole diameter = 14 mm Max load (pull out) = 16 kN	Length = 120 mm Size = M12 Drill hole diameter = 14 mm Max load (pull out) = 16 kN
To fix U-profile (on a FLEX IMPACT® post)	Bolts: M8x35 - ZC (1x) Nuts: butterfly nut- ZC (1x)	-

\*Fire class HB = Slow burning; classification according to UL94: US Standard for Safety of Flammability of Plastics  
\*\*Ask your local sales office for resistance to specific chemicals.

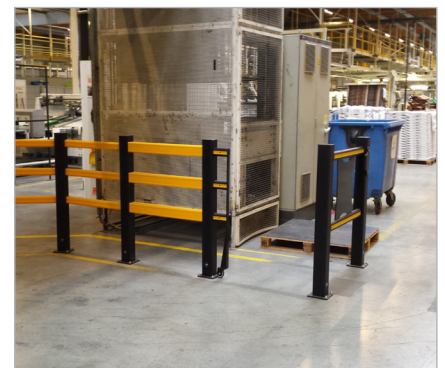
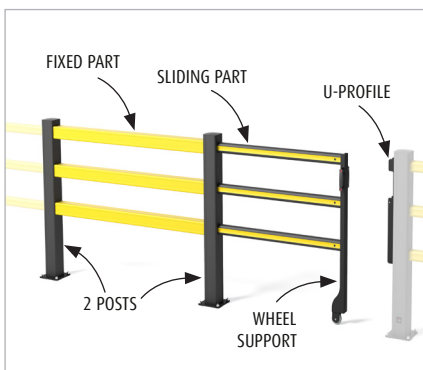

**FEATURES AND FUNCTIONALITY**

**SIZE AND DIMENSIONS**

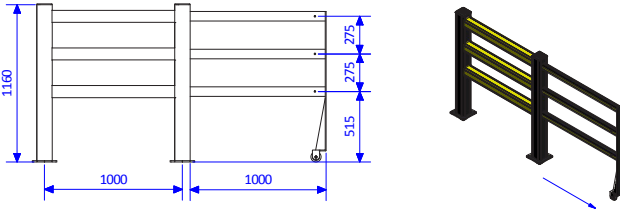
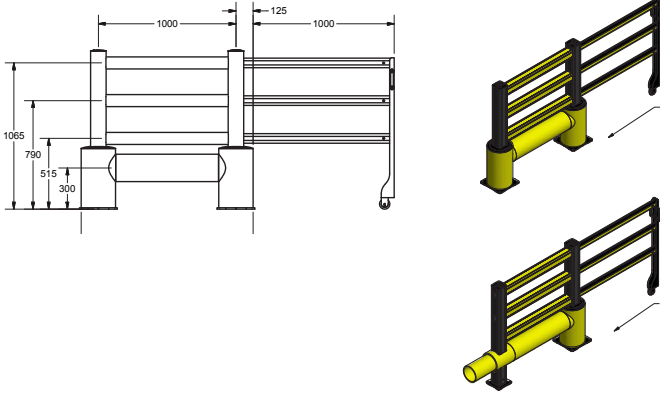
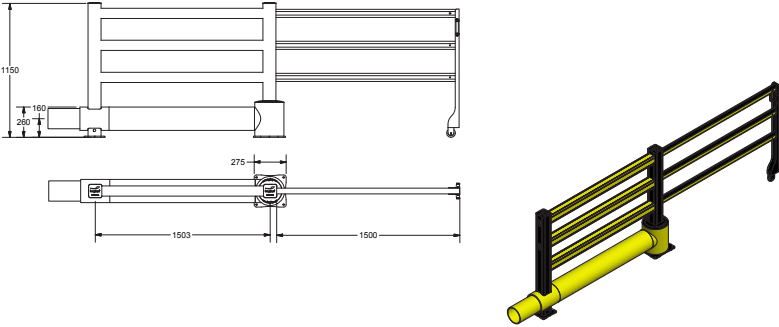
<p>HP plus</p>		<p>Standard Length</p> <p>1000 mm 1500 mm 2000 mm</p>	<p>Variable Length</p> <p>500 mm up to 1999 mm</p>
<p>TB400 Plus</p>		<p>Standard Length</p> <p>1000 mm 1500 mm 2000 mm</p>	<p>Variable Length</p> <p>500 mm up to 1999 mm</p>
<p>TB260 Plus</p>		<p>Standard Length</p> <p>1000 mm 1500 mm 2000 mm</p>	<p>Variable Length</p> <p>500 mm up to 1999 mm</p>

## REFERENCES - SLIDING GATE - HP

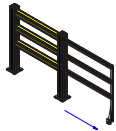
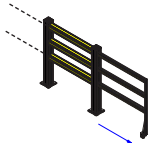
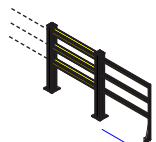
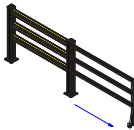
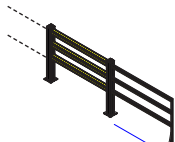
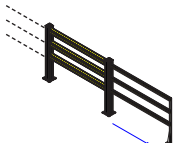
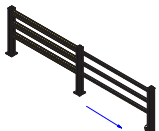
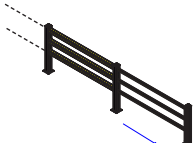
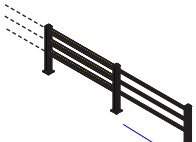
SG0200-1000-0001YE	SL.G - HP - 1000mm open - Blank - YE	
SG0200-1000-C201YE	SL.G - HP - 1000mm open - Cont.2R - YE	
SG0200-1000-C301YE	SL.G - HP - 1000mm open - Cont.3R - YE	
SG0200-1500-0001YE	SL.G - HP - 1500mm open - Blank - YE	
SG0200-1500-C201YE	SL.G - HP - 1500mm open - Cont.2R - YE	
SG0200-1500-C301YE	SL.G - HP - 1500mm open - Cont.3R - YE	
SG0200-2000-0001YE	SL.G - HP - 2000mm open - Blank - YE	
SG0200-2000-C201YE	SL.G - HP - 2000mm open - Cont.2R - YE	
SG0200-2000-C301YE	SL.G - HP - 2000mm open - Cont.3R - YE	
SG0201-1999-0001YE	SL.G - HP - 1500-1999mm! open - Blank - YE	
SG0201-1999-C201YE	SL.G - HP - 1500-1999mm! open - Cont.2R - YE	
SG0201-1999-C301YE	SL.G - HP - 1500-1999mm! open - Cont.3R - YE	

## REFERENCES - SLIDING GATE - TB400 PLUS

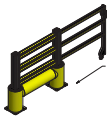
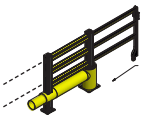
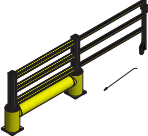
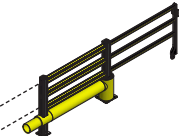
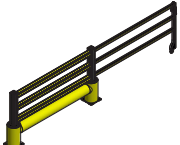
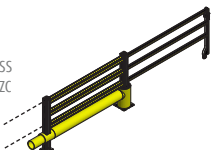
SG0300-1000-0001YE SG0300-1000-0001YES SG0300-1000-0001YEZ	SL.G - TB400 Plus - 1000mm open - Blank - YE SL.G - TB400 Plus - 1000mm open - Blank - YE - SS SL.G - TB400 Plus - 1000mm open - Blank - YE - ZC	
SG0300-1000-CT02YE SG0300-1000-CT02YES SG0300-1000-CT02YEZ	SL.G - TB400 Plus-1000mm open - Cont. TB - YE SL.G - TB400 Plus-1000mm open - Cont. TB - YE - SS SL.G - TB400 Plus-1000mm open - Cont. TB - YE - ZC	
SG0300-1500-0001YE SG0300-1500-0001YES SG0300-1500-0001YEZ	SL.G - TB400 Plus-1500mm open - Blank - YE SL.G - TB400 Plus-1500mm open - Blank - YE - SS SL.G - TB400 Plus-1500mm open - Blank - YE - ZC	
SG0300-1500-CT02YE SG0300-1500-CT02YES SG0300-1500-CT02YEZ	SL.G - TB400 Plus-1500mm open - Cont. TB - YE SL.G - TB400 Plus-1500mm open - Cont. TB - YE - SS SL.G - TB400 Plus-1500mm open - Cont. TB - YE - ZC	
SG0300-2000-0001YE SG0300-2000-0001YES SG0300-2000-0001YEZ	SL.G - TB400 Plus-2000mm open - Blank - YE SL.G - TB400 Plus-2000mm open - Blank - YE - SS SL.G - TB400 Plus-2000mm open - Blank - YE - ZC	
SG0300-2000-CT02YE SG0300-2000-CT02YES SG0300-2000-CT02YEZ	SL.G - TB400 Plus-2000mm open - Cont. TB - YE SL.G - TB400 Plus-2000mm open - Cont. TB - YE - SS SL.G - TB400 Plus-2000mm open - Cont. TB - YE - ZC	
SG0308-1999-0001YE SG0308-1999-0001YES SG0308-1999-0001YEZ	SL.G - TB400 Plus-1500-1999mm! open - Blank - YE SL.G - TB400 Plus-1500-1999mm! open - Blank - YE - SS SL.G - TB400 Plus-1500-1999mm! open - Blank - YE - ZC	
SG0308-1999-CT02YE SG0308-1999-CT02YES SG0308-1999-CT02YEZ	SL.G - TB400 Plus-1500-1999mm! open - Cont. TB - YE SL.G - TB400 Plus-1500-1999mm! open - Cont. TB - YE - SS SL.G - TB400 Plus-1500-1999mm! open - Cont. TB - YE - ZC	

**Boplan bvba Head Office** | Muizelstraat 12, 8560 Moorsele, Belgium | +32 56 20 64 20 | sales@boplan.com | www.boplan.com

DISCLAIMER: ALL PRODUCT SPECIFICATIONS AND DATA ARE SUBJECT TO CHANGE WITHOUT NOTICE TO IMPROVE RELIABILITY, FUNCTION OR DESIGN OR OTHERWISE.  
© Boplan, the Boplan logo, Flex Impact and RackBull are trademarks of Boplan bvba. All other trademarks are property of their respective owners.

## REFERENCES - SLIDING GATE - TB260 PLUS

<p>SG0301-1000-0001YE SG0301-1000-0001YES SG0301-1000-0001YEZ</p>	<p>SL.G - TB260 Plus - 1000mm open - Blank - YE SL.G - TB260 Plus - 1000mm open - Blank - YE - SS SL.G - TB260 Plus - 1000mm open - Blank - YE - ZC</p>	<p>SG0301-2000-0001YE SG0301-2000-0001YES SG0301-2000-0001YEZ</p>	<p>SL.G - TB260 Plus-2000mm open - Blank - YE SL.G - TB260 Plus-2000mm open - Blank - YE - SS SL.G - TB260 Plus-2000mm open - Blank - YE - ZC</p>
<p>SG0301-1000-CT02YE SG0301-1000-CT02YES SG0301-1000-CT02YEZ</p>	<p>SL.G - TB260 Plus-1000mm open - Cont. TP260 - YE SL.G - TB260 Plus-1000mm open - Cont. TP260 - YE - SS SL.G - TB260 Plus-1000mm open - Cont. TP260 - YE - ZC</p>	<p>SG0301-2000-CT02YE SG0301-2000-CT02YES SG0301-2000-CT02YEZ</p>	<p>SL.G - TB260 Plus-2000mm open - Cont. TP260 - YE SL.G - TB260 Plus-2000mm open - Cont. TP260 - YE - SS SL.G - TB260 Plus-2000mm open - Cont. TP260 - YE - ZC</p>
<p>SG0301-1500-0001YE SG0301-1500-0001YES SG0301-1500-0001YEZ</p>	<p>SL.G - TB260 Plus-1500mm open - Blank - YE SL.G - TB260 Plus-1500mm open - Blank - YE - SS SL.G - TB260 Plus-1500mm open - Blank - YE - ZC</p>	<p>SG0309-1999-0001YE SG0309-1999-0001YES SG0309-1999-0001YEZ</p>	<p>SL.G - TB260 Plus-1500-1999mm! open - Blank - YE SL.G - TB260 Plus-1500-1999mm! open - Blank - YE - SS SL.G - TB260 Plus-1500-1999mm! open - Blank - YE - ZC</p>
<p>SG0301-1500-CT02YE SG0301-1500-CT02YES SG0301-1500-CT02YEZ</p>	<p>SL.G - TB260 Plus-1500mm open - Cont. TP 260 - YE SL.G - TB260 Plus-1500mm open - Cont. TP 260 - YE - SS SL.G - TB260 Plus-1500mm open - Cont. TP 260 - YE - ZC</p>	<p>SG0309-1999-CT02YE SG0309-1999-CT02YES SG0309-1999-CT02YEZ</p>	<p>SL.G - TB260 Plus-1500-1999mm! open - Cont. TP260 - YE SL.G - TB260 Plus-1500-1999mm! open - Cont. TP260 - YE - SS SL.G - TB260 Plus-1500-1999mm! open - Cont. TP260 - YE - ZC</p>

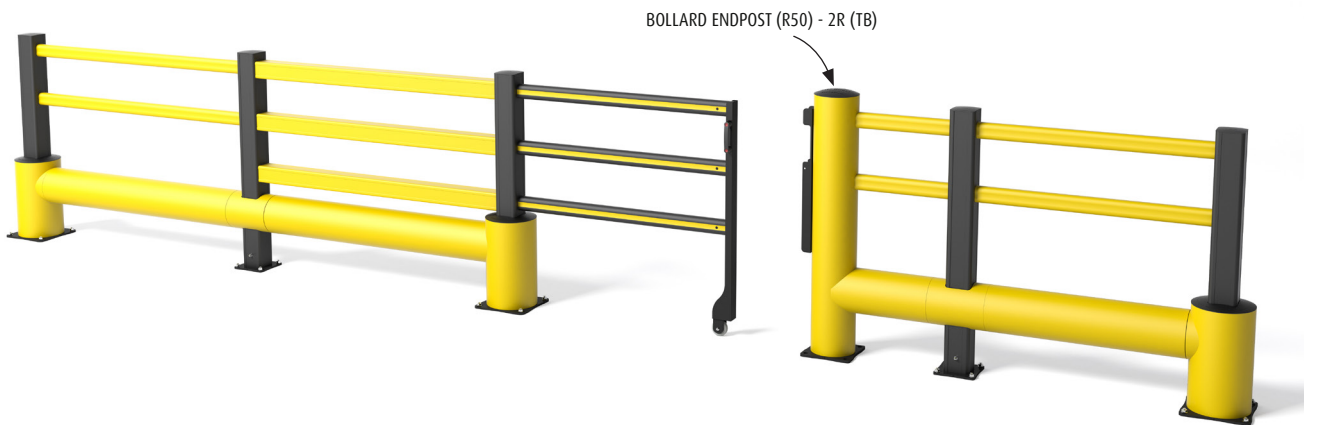
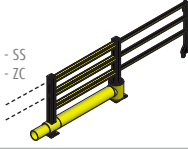

EXAMPLE SET UP FOR A SLIDING GATE TB400 PLUS  
IN COMBINATION WITH A BOLLARD